

NO.	PART#	MATERIAL	TREAT.	QTY.
29	MISC019	NITRILE 90	N	2
28	MISC015	NITRILE 80 - FDA	N	2
27	MISC009	A2	N	1
26	SF027	Ø 1/4" 4305 PDP	N	1
25	MISC005	A2	N	1
24	SF028	Ø 18 CZ121	Y	1
23	MISC020	NITRILE 90 - FDA	N	1
22	SF017	Ø 30 NATURAL PP	N	1
21	SF038	Ø 18 4305 PDP	N	1
20	MISC159	S302	N	1
19	MISC017	NITRILE 90 - FDA	N	1
18	MISC001	A2	N	1
17	MISC016	NITRILE 80	N	1
16	SF006	Ø 10 4305 PDP	N	1
15	MISC022	NITRILE 70	N	1
14	MISC023	NITRILE 70 - FDA	N	2
13	SF061	Ø 1/4" 4305 PDP	N	2
12	SF026	Ø 10 CZ121	Y	1
11	SF065	Ø 3/8" x 18g S304	N	1
10	SF015	Ø 3/8" x 18g S304	N	1
9	SF050	Ø 1/2" 4305 PDP	N	2
8	SF106	Ø 57 S304	N	1
7	MISC158	S304	N	1
6	SF062	Ø 50 x 40 ACRYLIC	N	1
5	SF005	Ø 57 S304	N	1
4	SF031	Ø 1/2" CZ121	Y	2
3	MISC002	A2	N	2
2	SF042	CZ121	Y	1
1	SF039	Ø 1/2" CZ121	Y	1

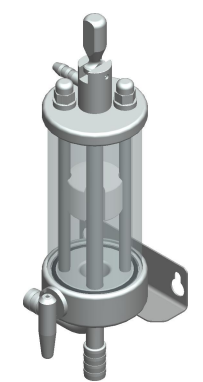
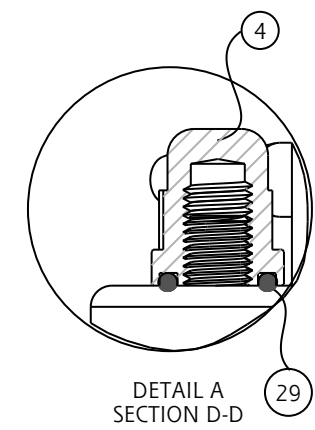
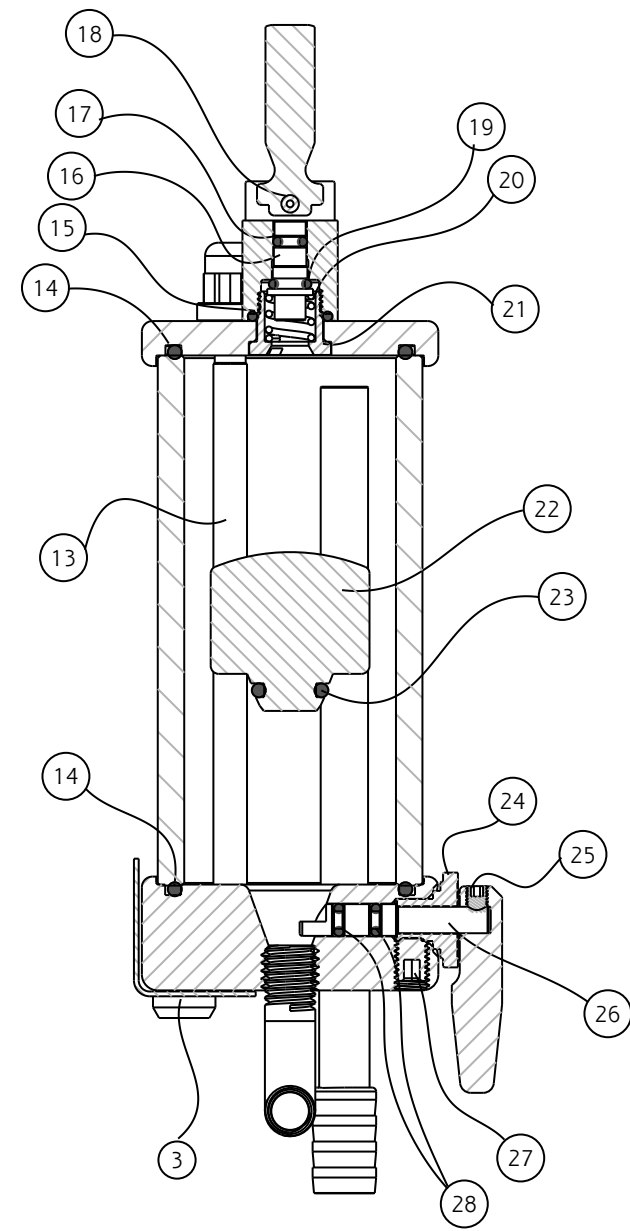
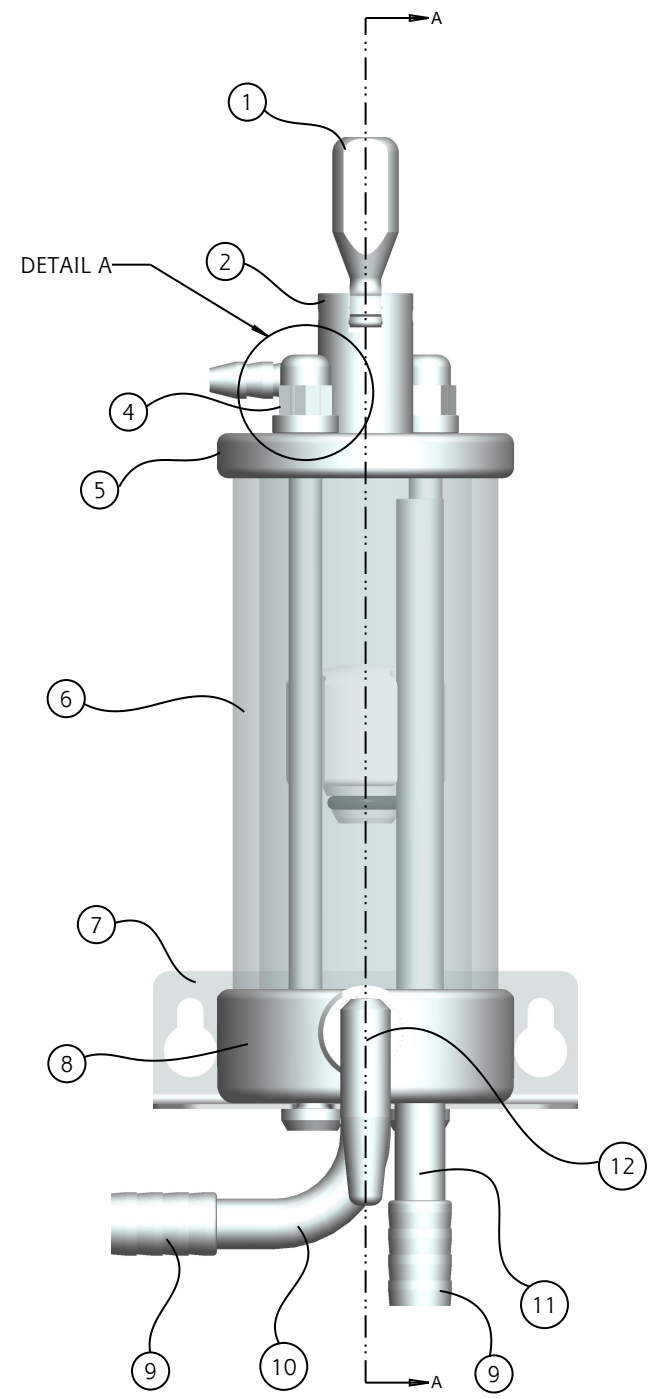

ECN	REV	DATE
414	1	15/03/07
	0	25/9/06